

# Fundamentplatte Variante 1

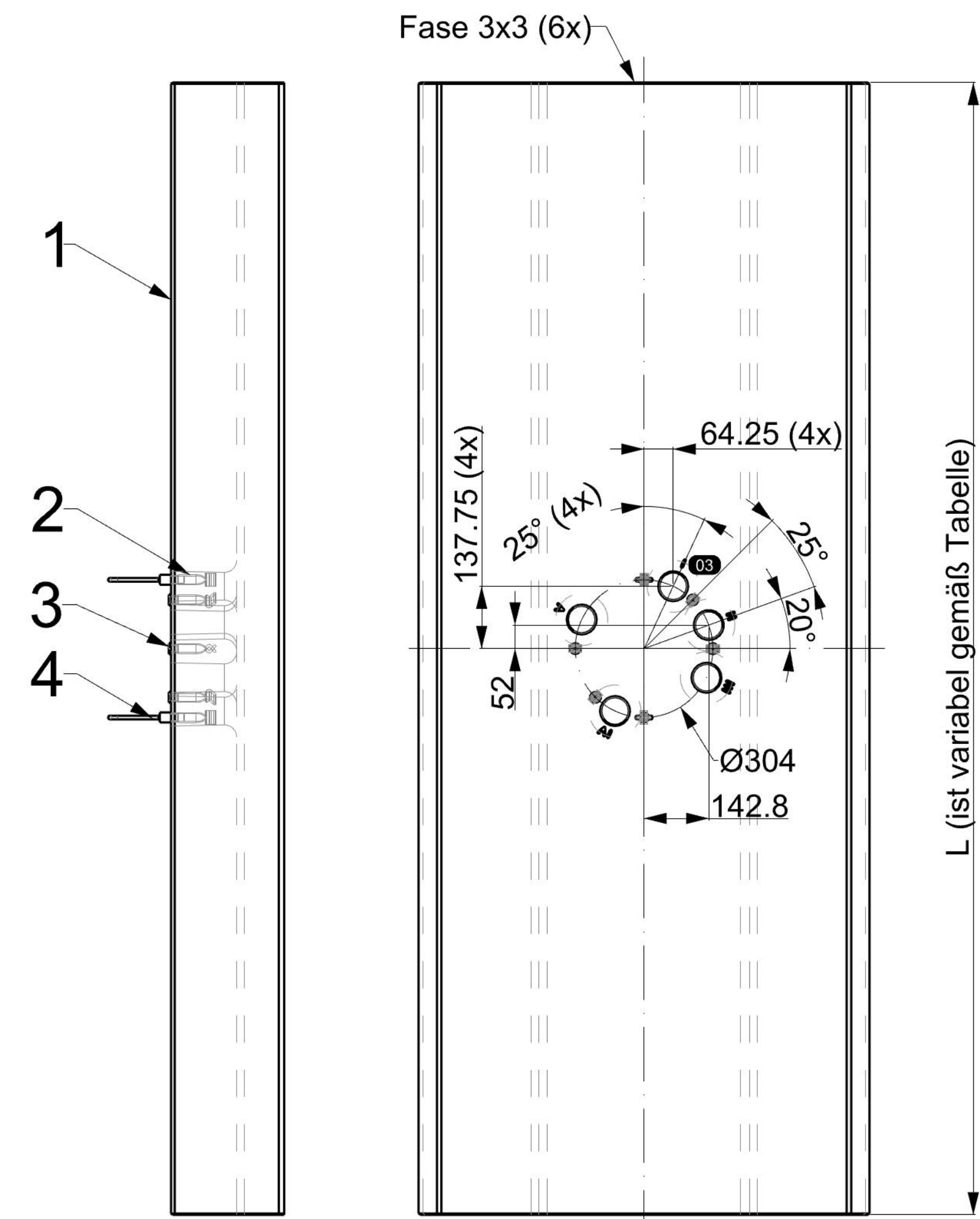

...	-
...	-
...	-
3500	-
3000	-
2650	-
2500	-
L (Variante 1)	Bemerkungen

# Fundamentplatte Variante 2

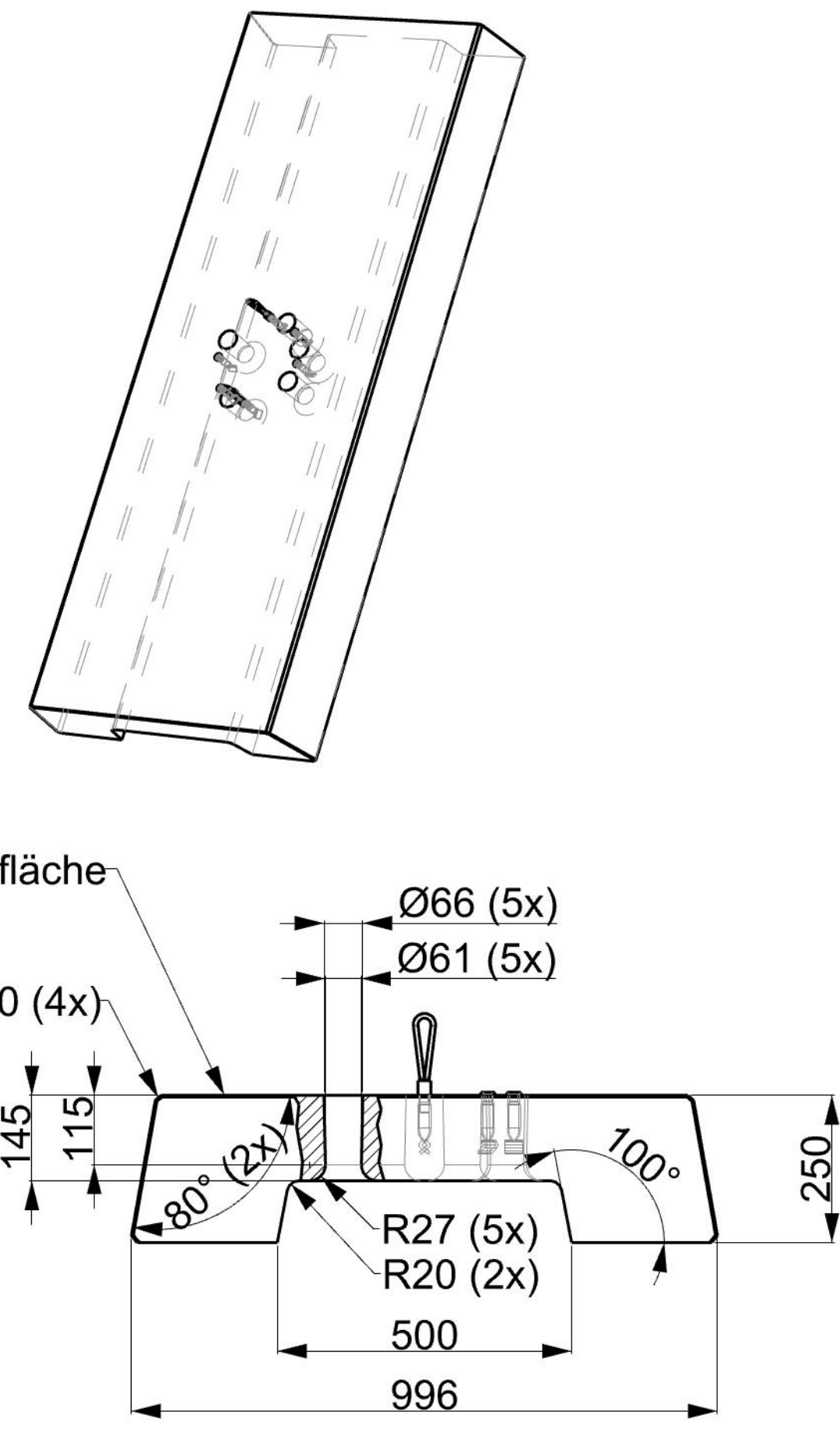
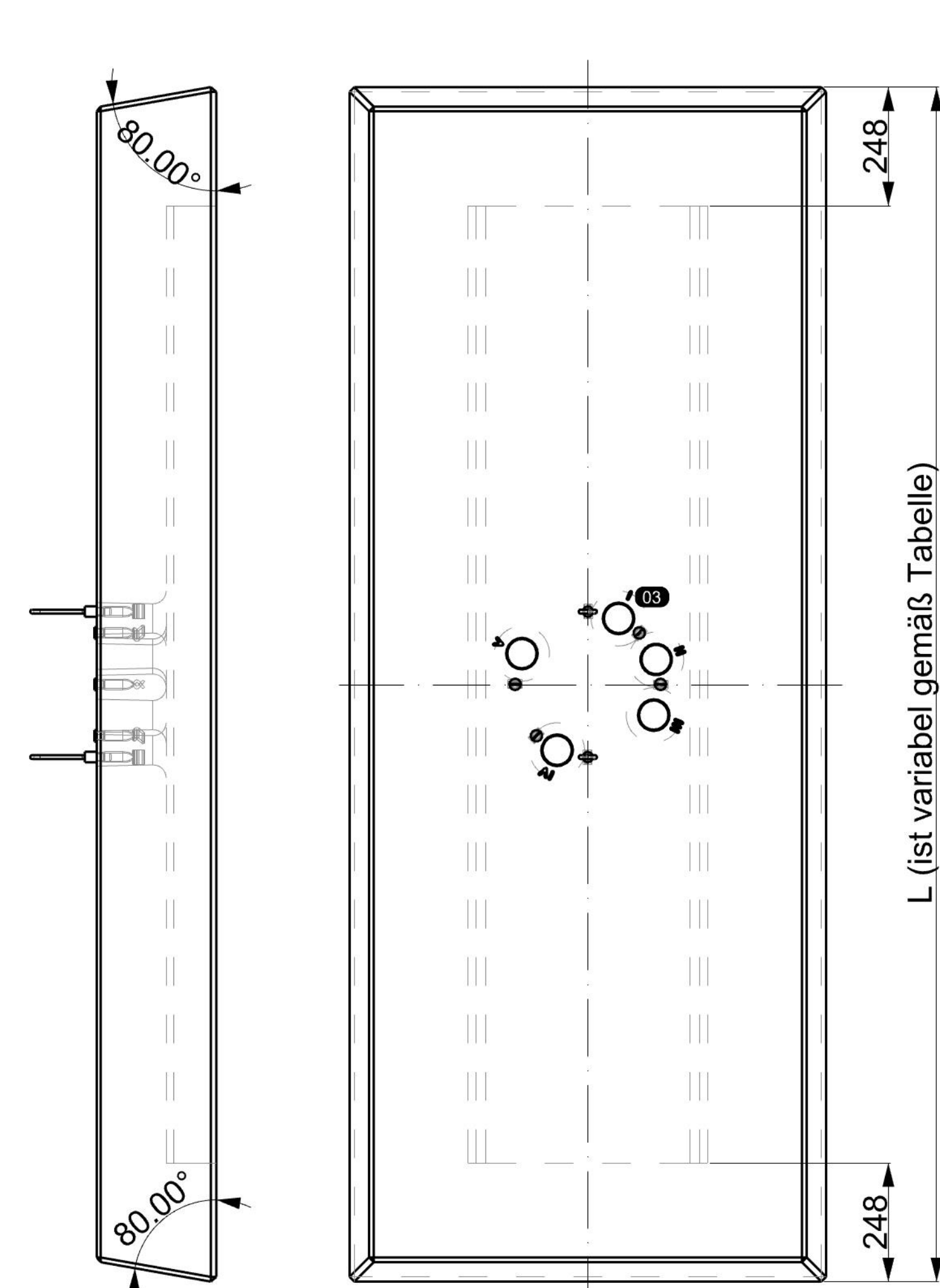
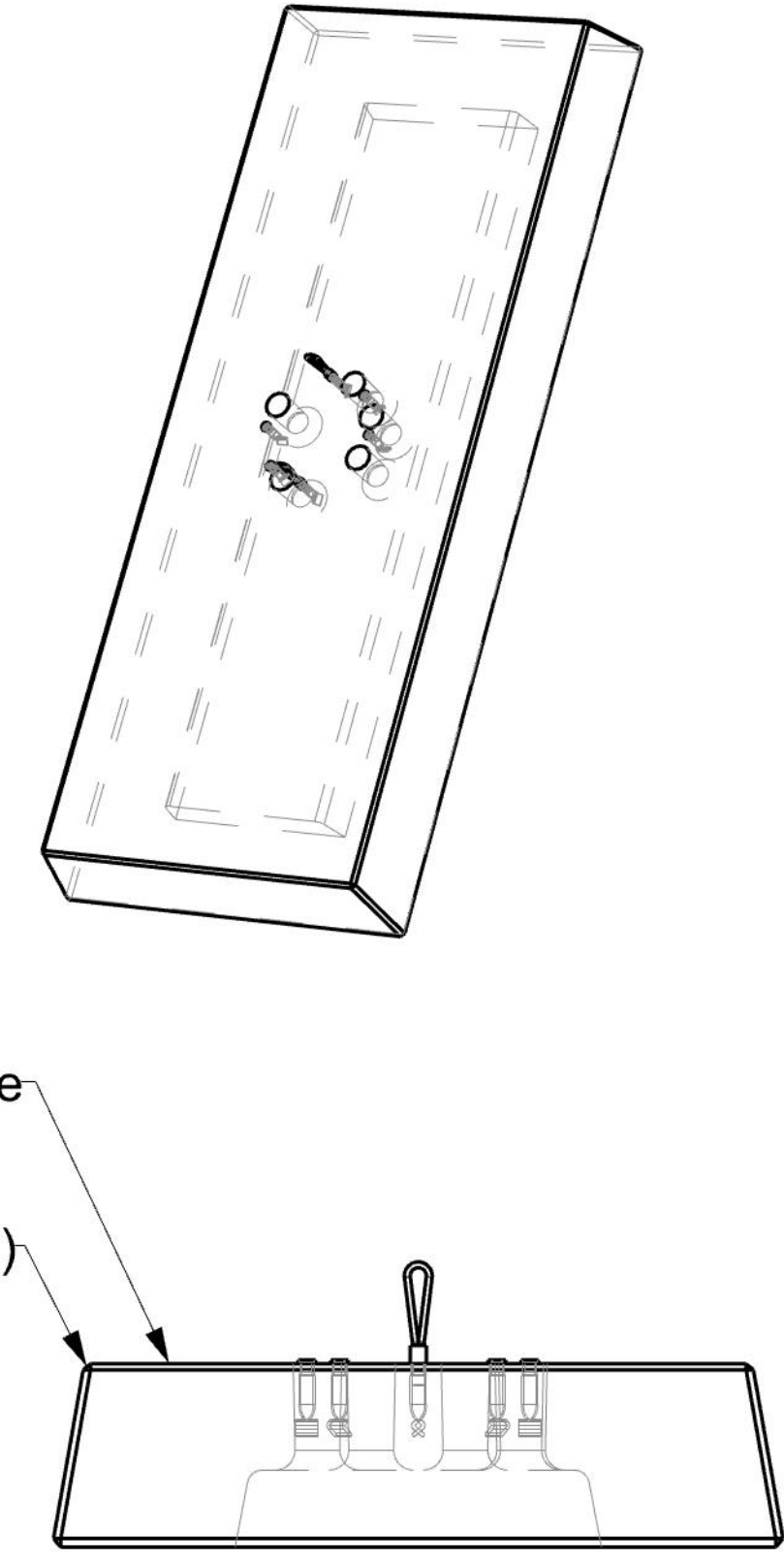

...	-
...	-
...	-
...	-
2650	-
2400	-
2000	-
L (Variante 2)	Bemerkungen

# Fundamentplatte Variante 3

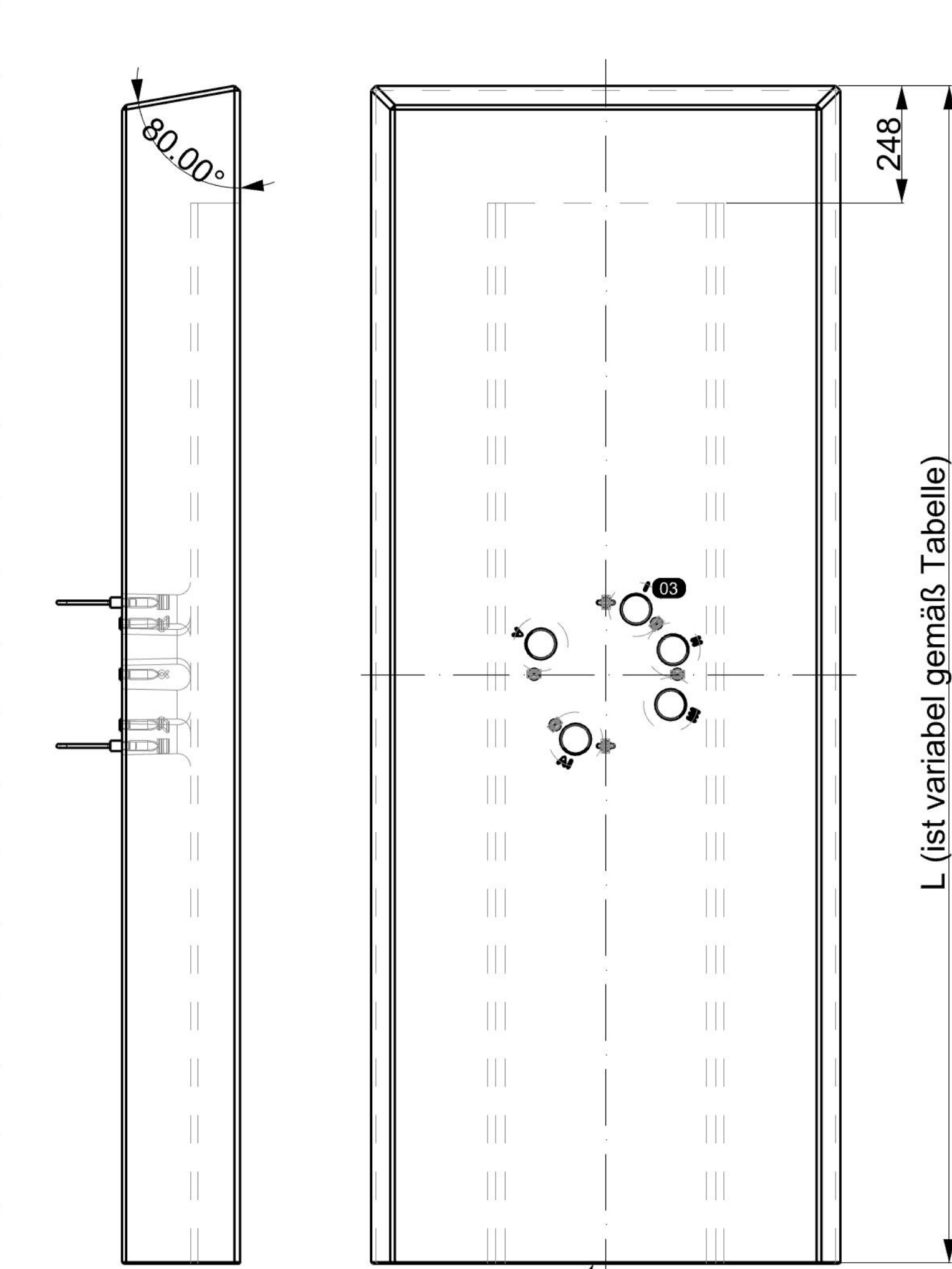
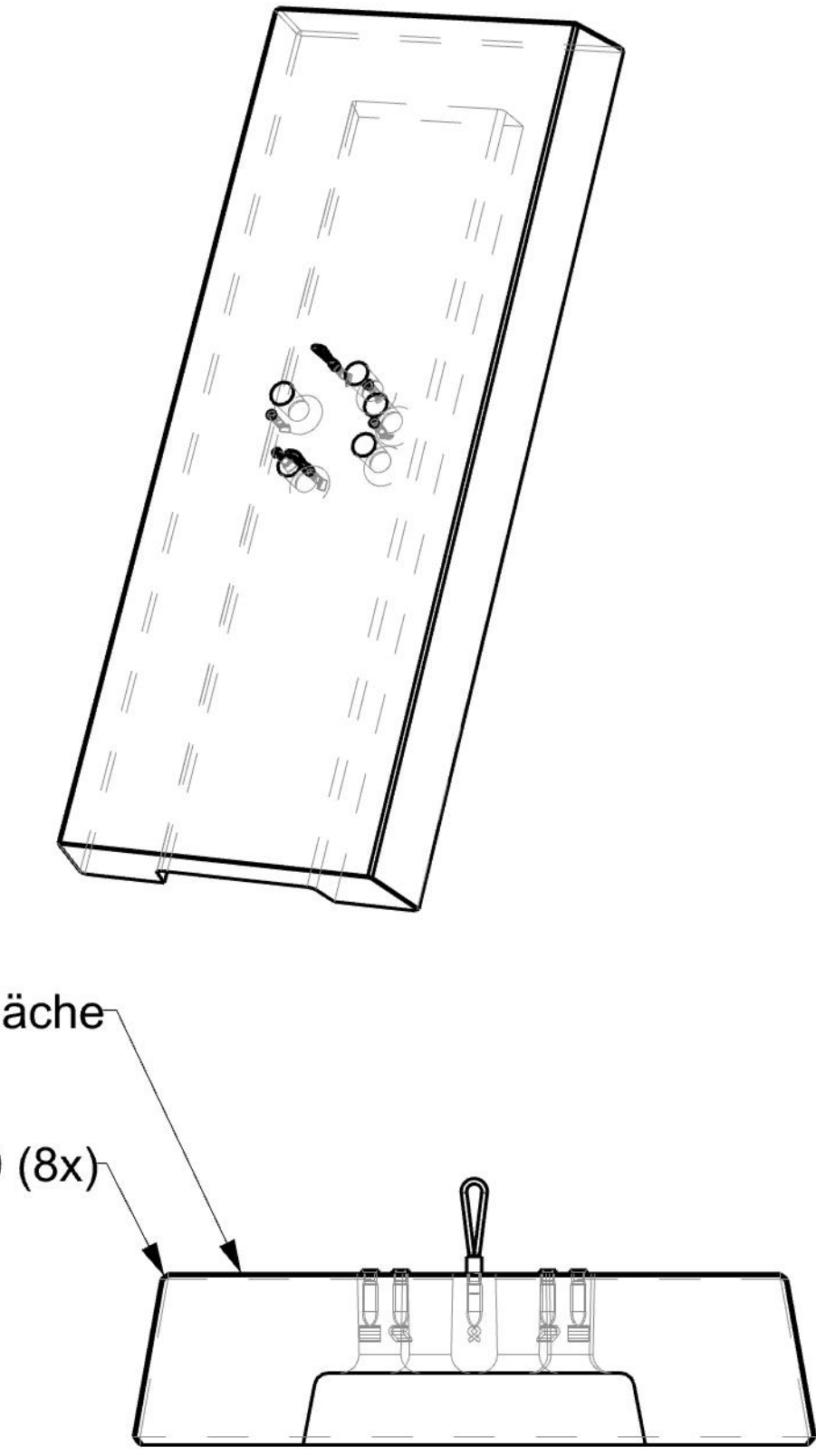

...	-
...	-
...	-
...	-
3500	-
3000	-
2650	-
2500	-
L (Variante 3)	Bemerkungen

# Fundamentplatte Variante 4

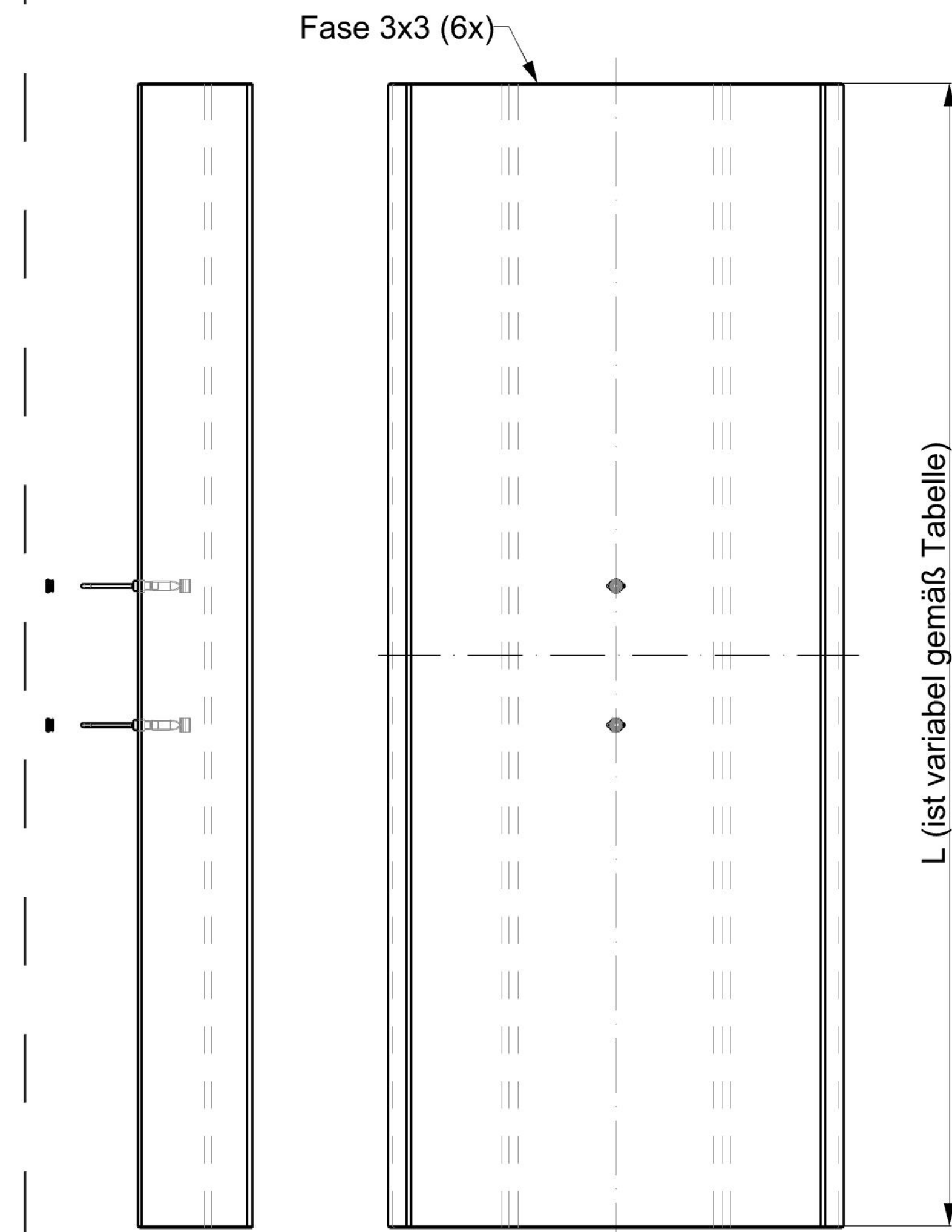
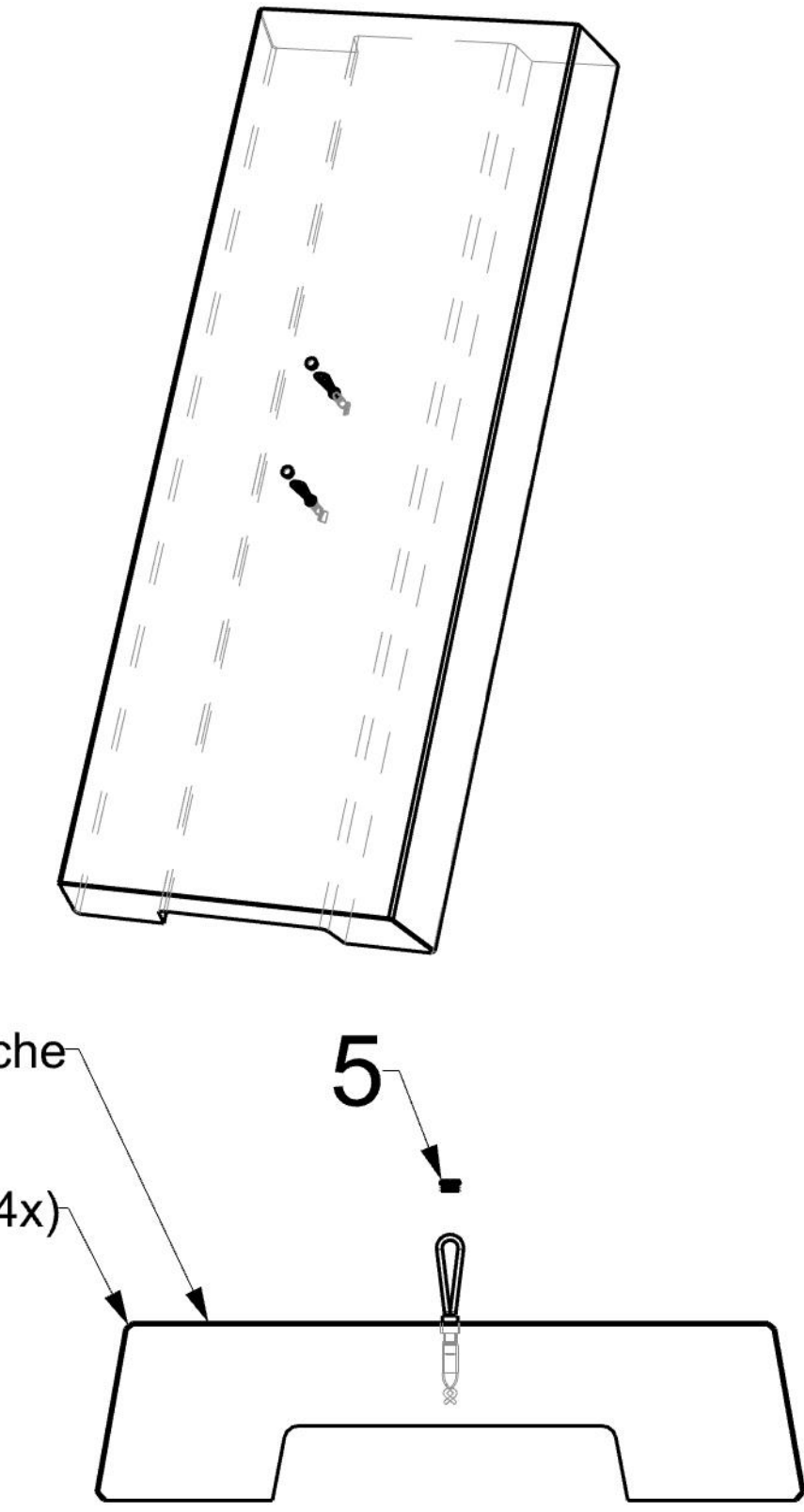

...	-
...	-
...	-
...	-
3500	-
3000	-
2650	-
2500	-
L (Variante 4)	Bemerkungen

# Fundamentplatte Variante 5

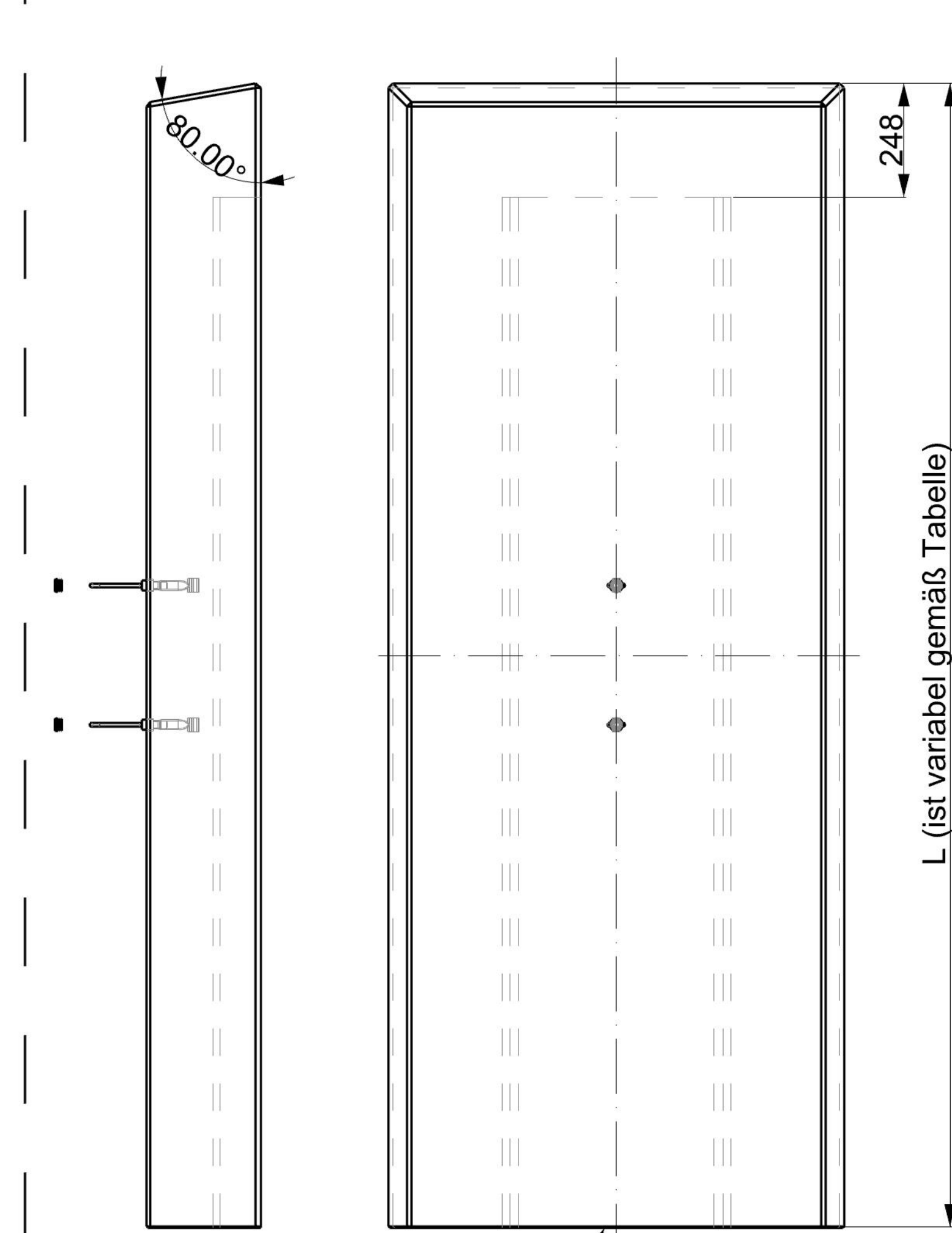
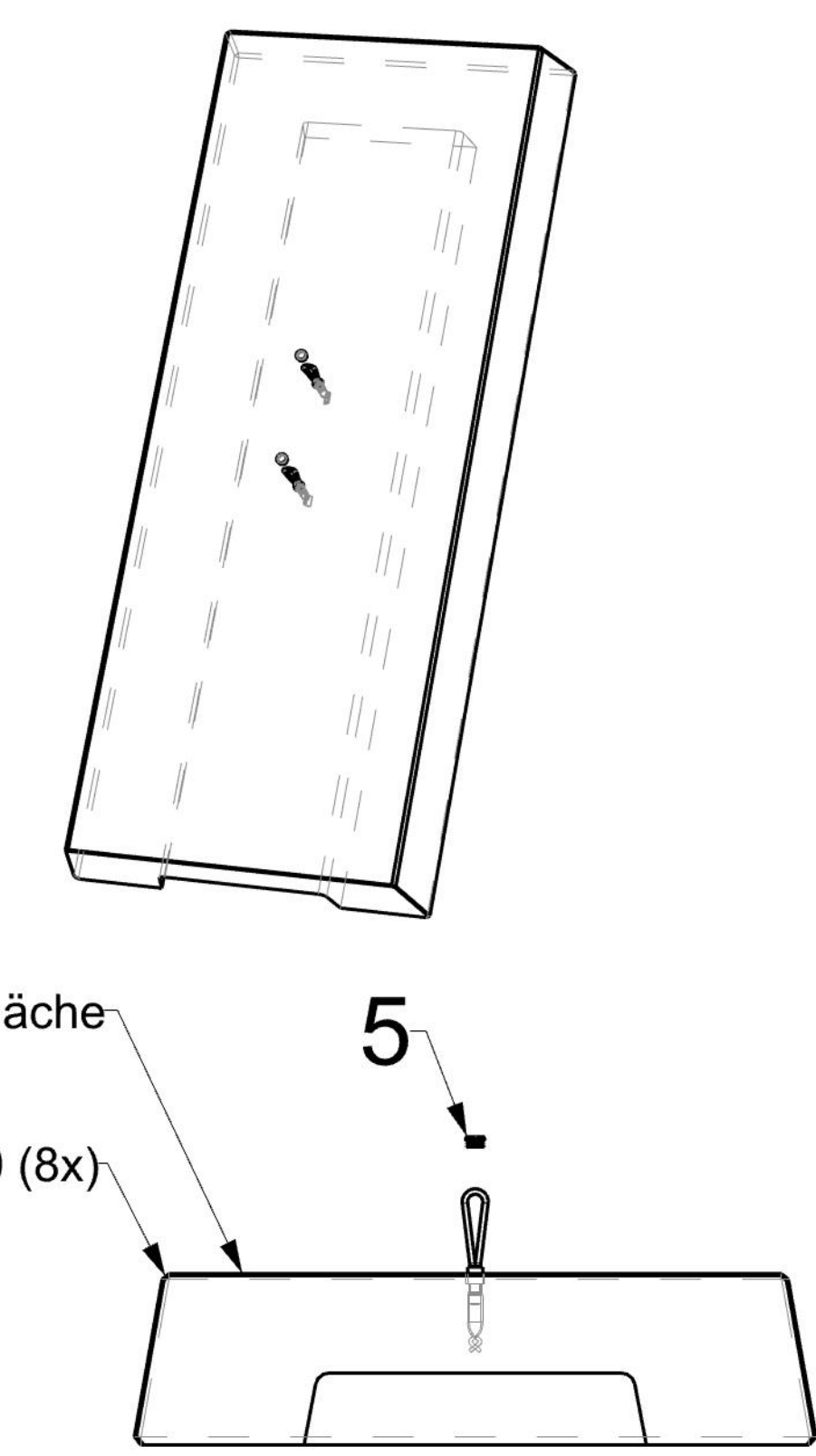

...	-
...	-
...	-
...	-
...	-
1200	-
L (Variante 5)	Bemerkungen

## Installationsvarianten

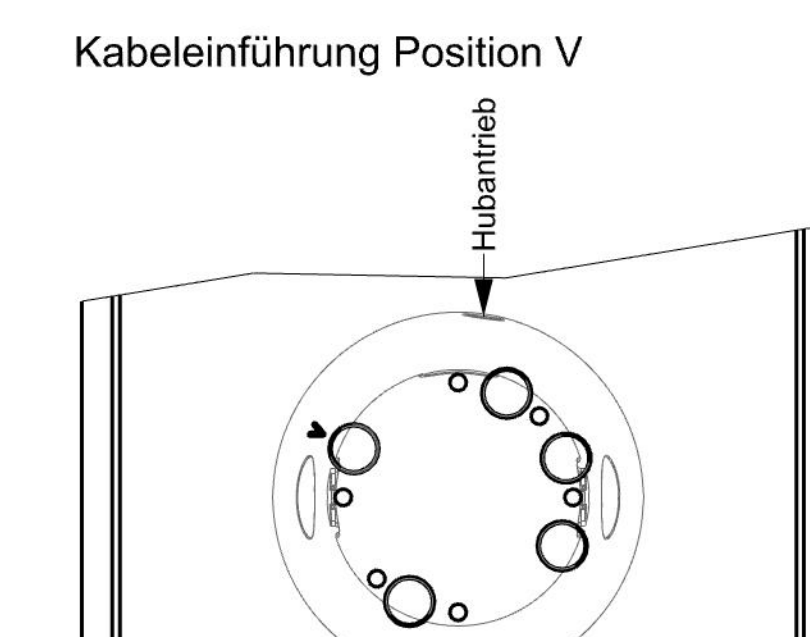
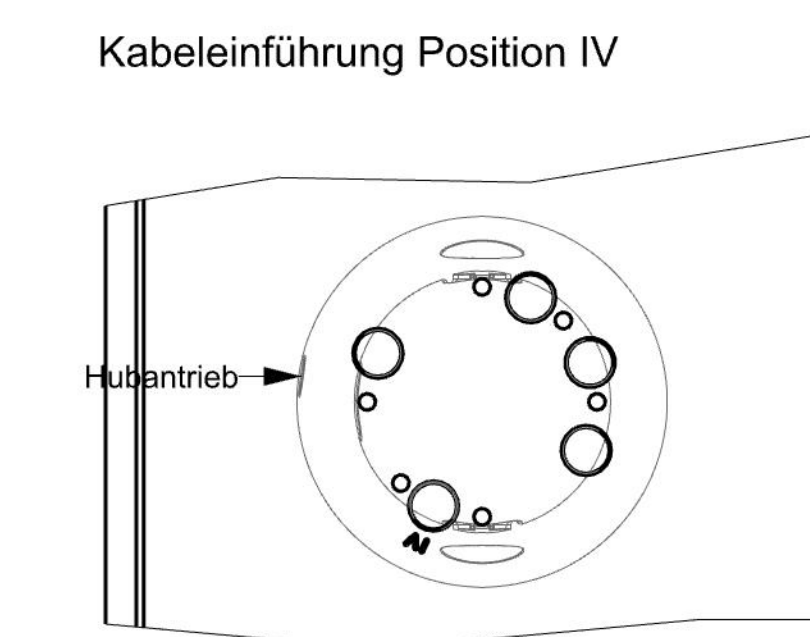
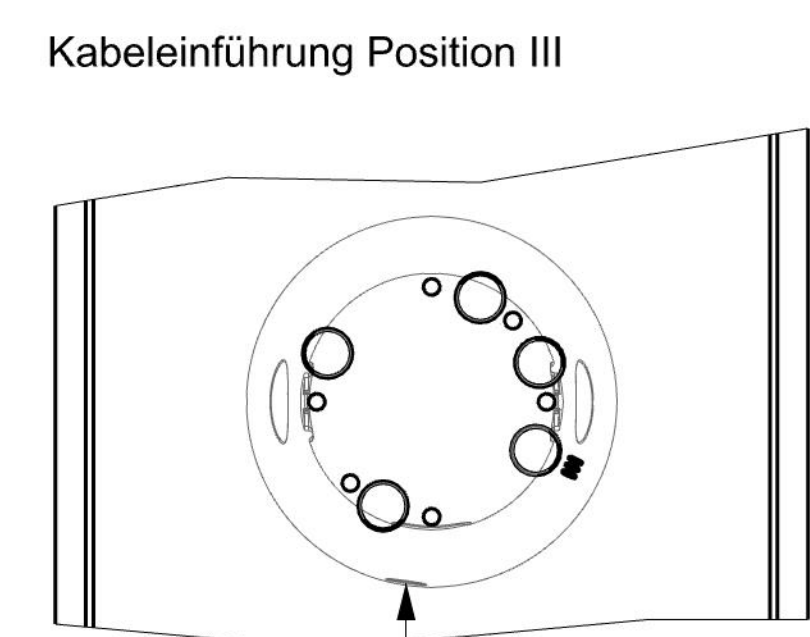
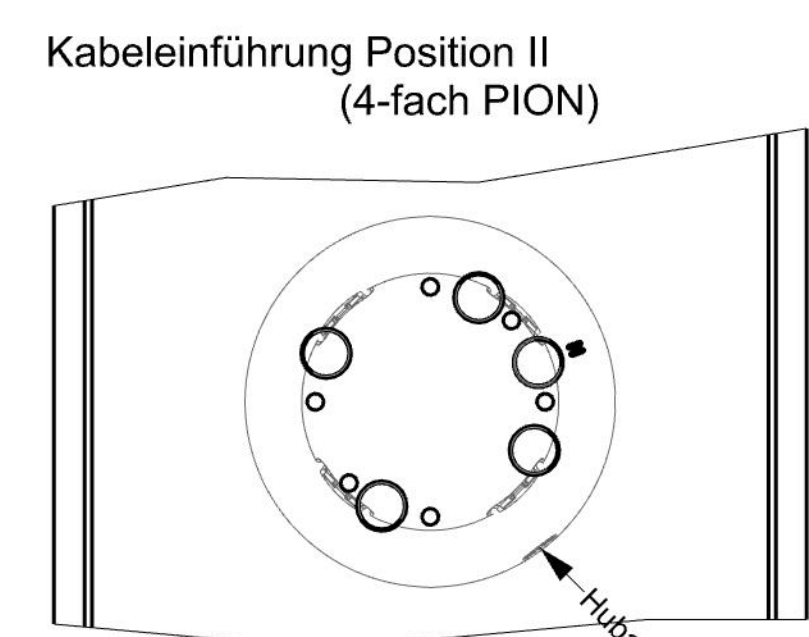
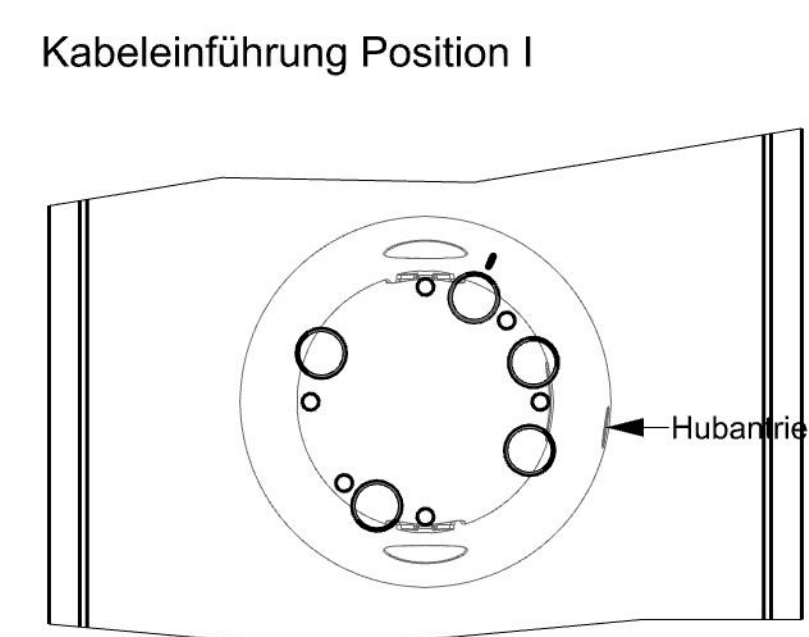

Maße sind in mm angegeben.  
Nicht angegebene Maße sind dem 3D-Modell zu entnehmen.

Pos.	Menge	Benennung	Werkstoff	Bemerkung
5	0	2	Abdeckstopfen 72ASO1224VA, Fa. Philipp	Edelstahl Wind im Beipack mitgeliefert
4	2	2	Seilschlaufe M16	- Traglast mind. 1 t
3	4	0	Schutzstopfen k5216mg, Fa. Schroeder	Kunststoff -
2	6	2	Hülensdübel K1162VA, Fa. Schroeder	Edelstahl -
1	1	1	Betonfundament inkl. Bewehrung (nicht dargestellt)	C35/45 Bewehrung nach Vorgabe Statik

Verwendungsbereich	Zul. Abw. nach DIN 18202	Oberfläche	Mischstab 1:10	Gewicht	-
-	-	-	-	-	-
-	-	-	-	-	-
-	-	-	-	-	-
-	-	-	-	-	-
-	-	-	-	-	-
04	07.10.21	08	07.10.21	08	08
05	11.01.21	09	11.01.21	09	09
06	11.09.20	10	11.09.20	10	10
07	-	11	-	11	-
08	-	12	-	12	-
09	-	13	-	13	-
10	-	14	-	14	-
11	-	15	-	15	-
12	-	16	-	16	-
13	-	17	-	17	-
14	-	18	-	18	-
15	-	19	-	19	-
16	-	20	-	20	-
17	-	21	-	21	-
18	-	22	-	22	-
19	-	23	-	23	-
20	-	24	-	24	-
21	-	25	-	25	-
22	-	26	-	26	-
23	-	27	-	27	-
24	-	28	-	28	-
25	-	29	-	29	-
26	-	30	-	30	-
27	-	31	-	31	-
28	-	32	-	32	-
29	-	33	-	33	-
30	-	34	-	34	-
31	-	35	-	35	-
32	-	36	-	36	-
33	-	37	-	37	-
34	-	38	-	38	-
35	-	39	-	39	-
36	-	40	-	40	-
37	-	41	-	41	-
38	-	42	-	42	-
39	-	43	-	43	-
40	-	44	-	44	-
41	-	45	-	45	-
42	-	46	-	46	-
43	-	47	-	47	-
44	-	48	-	48	-
45	-	49	-	49	-
46	-	50	-	50	-
47	-	51	-	51	-
48	-	52	-	52	-
49	-	53	-	53	-
50	-	54	-	54	-
51	-	55	-	55	-
52	-	56	-	56	-
53	-	57	-	57	-
54	-	58	-	58	-
55	-	59	-	59	-
56	-	60	-	60	-
57	-	61	-	61	-
58	-	62	-	62	-
59	-	63	-	63	-
60	-	64	-	64	-
61	-	65	-	65	-
62	-	66	-	66	-
63	-	67	-	67	-
64	-	68	-	68	-
65	-	69	-	69	-
66	-	70	-	70	-
67	-	71	-	71	-
68	-	72	-	72	-
69	-	73	-	73	-
70	-	74	-	74	-
71	-	75	-	75	-
72	-	76	-	76	-
73	-	77	-	77	-
74	-	78	-	78	-
75	-	79	-	79	-
76	-	80	-	80	-
77	-	81	-	81	-
78	-	82	-	82	-
79	-	83	-	83	-
80	-	84	-	84	-
81	-	85	-	85	-
82	-	86	-	86	-
83	-	87	-	87	-
84	-	88	-	88	-
85	-	89	-	89	-
86	-	90	-	90	-
87	-	91	-	91	-
88	-	92	-	92	-
89	-	93	-	93	-
90	-	94	-	94	-
91	-	95	-	95	-
92	-	96	-	96	-
93	-	97	-	97	-
94	-	98	-	98	-
95	-	99	-	99	-
96	-	100	-	100	-

1  
2  
3  
4  
5  
6  
7  
8  
9  
10  
11  
12  
13  
14  
15  
16  
17  
18  
19  
20  
21  
22  
23  
A  
B  
C  
D  
E  
F  
G  
H  
I  
J  
K  
L  
M  
N  
O  
P  
A0